

# *Octane*<sup>®</sup>

F I T N E S S



**Q37c**

**Q37ci**

O P E R A T I O N S M A N U A L

**This product is intended for household use.**

## **IMPORTANT SAFETY INSTRUCTIONS**

### **Please Read and Save These Instructions**

**WARNING!** Before beginning this or any exercise program, consult your physician. This is especially important for persons over 35 or persons with pre-existing health conditions. If at any time during exercise you experience chest pains, nausea, dizziness, or shortness of breath, stop exercising immediately and consult your physician before starting again.

Read this Operations Manual before operating this elliptical cross trainer.

**WARNING!** When using an electrical product, basic precautions should always be followed.

To reduce the risk of burns, fire, electrical shock or injury to people:

- Use this exercise product for its intended use as described in this Operations Manual. **Do not** modify the product in any way.
- **Do not** remove the plastic shrouds from the machine. Service should be performed only by an authorized Octane Fitness service representative. Moving parts contained under the shrouds can be extremely dangerous when not covered.
- **Never** operate this elliptical cross trainer if it has a damaged cord or plug, if it is not working properly, if it has been dropped or damaged, or dropped in water. Return the cross trainer to your local dealer or Octane Fitness for examination and repair.
- **Never** operate this elliptical cross trainer with the air openings blocked. Keep the air opening free of lint, hair, and the like.
- Keep the cord away from heated surfaces.
- **Do not** use outdoors.
- **Do not** operate this elliptical cross trainer where aerosol (spray) products are being used or where oxygen is being administered.
- **Do not** route power cables (such as the power cable for an optional attached LCD screen) through the interior of the machine or the upright tube.
- **Do not** mount an LCD screen weighing more than 12.5 lbs. (5.7 kg) on the optional LCD mounting arm.
- **Never** place the power cord under carpeting or place any object on top of the power cord which may pinch and/or damage it.
- Use only the power cord provided with your Octane Fitness elliptical cross trainer.
- Unplug your Octane Fitness elliptical cross trainer before moving it.

## **SAVE THESE INSTRUCTIONS**

## OTHER IMPORTANT SAFETY PRECAUTIONS

- Place the elliptical cross trainer on a level surface with at least two feet of clearance behind the pedal at its furthest back position.
- To protect the floor or carpet from damage, place a mat under your elliptical cross trainer.
- Keep children under the age of 13 off the elliptical cross trainer at all times.
- When the elliptical cross trainer is in use, children and pets should be kept clear of the area.
- Wear appropriate exercise clothing and shoes for your workout; do not wear loose clothing.
- Use care when getting on or off the Octane Fitness elliptical cross trainer. Never step on or off the unit while the foot pedals are still moving.
- Always face forward. Never attempt to turn around on the Octane Fitness elliptical cross trainer.
- Do not sit, stand, or climb on the front plastic shroud, electronic console, or stationary handlebars.
- Keep your hands and feet clear of any opening or moving parts.
- Never insert or drop any object into any opening.
- Do not overexert yourself or work to exhaustion.
- If during your workout you feel any chest pain, nausea, dizziness, or abnormal symptoms, stop your workout immediately and consult your physician.
- Wipe down external surfaces of your cross trainer after use to remove sweat and dust.
- Monitor and check your Octane Fitness elliptical cross trainer on a regular basis. Refer to the Cleaning and Maintenance section of this manual for more information about the care of your Octane elliptical cross trainer.
- Inspect all parts of the elliptical cross trainer regularly. If service is required, contact your local dealer or Octane Fitness Customer Service for assistance.
- Take caution in moving your Octane Fitness elliptical cross trainer. Your elliptical weighs over 200 lbs. Use proper lifting techniques and/or get assistance when moving your product.

Product Dimensions:	1651mm x 737mm x 1550mm (65in x 29in x 61in)
Product Weight	220 lbs. (100 Kg)
Max User Weight	300 pounds (136 Kg)
<u>Power Supply/Electrical Specifications:</u>	
Input Rating	100-240~0.4A
Frequency	50-60Hz
Output Rating	+9V $\overline{\text{---}}$ 1.5A
Output Ripple	90mV
Output Current	1.5A Max
Safety	UL/CUL, TUV, PSE, CE, C-Tick, 3C, B-Mark

*This equipment complies where applicable with:*

73/23/EEC	Low Voltage Directive
89/36/EEC	Electromagnetic Compatibility (EN61000)
2002/95/EC	Restriction of Hazardous Substances (RoHS) Directive
2002/96/EC	WEEE Directive
EN957-9	Stationary training equipment
EN957-1:1997	Stationary training equipment
EN60335-1:2002	Household and similar electrical appliances - Safety
GPS	General Product Safety Regulations 2005



# HEART RATE FEATURE SAFETY GUIDELINES

Before using the Octane Fitness Q37c/Q37ci with HeartLogic™ Intelligence, read and follow these instructions:

## Contact Heart Rate Grips

- Clean the contact heart rate grips periodically to remove sweat and oils. Use a damp cloth with a mild detergent. Do not spray the hand grips directly with water or a cleaner; this could cause an electrical short.
- When holding the grips, grasp each contact heart rate grip so the contact sensor portion of the grip rests in the palm of your hand. Grip the contact sensors firmly, and keep your hands steady and in place.

## Wireless Chest Strap (Q37ci only)

- Exercisers may use the wireless heart rate transmitter provided with the Octane Fitness Q37ci or any Polar™-compatible (coded or non-coded) wireless heart rate transmitter.
- **Do not allow users to use the chest strap if they have a cardiac pacemaker or are taking prescription medication.** Medication or electrical impulses from the cardiac pacemaker can cause inaccurate heart rate readings.
- Please take care in handling the equipment as it is extremely sensitive.
- Do not bend the strips inside the chest strap as it can cause the strap to lose its conductivity.
- Handle the heart rate transmitter (chest strap) with care. Dropping the transmitter might cause damage and this could void the warranty.
- If the receiver (console) tries to process several signals simultaneously, an incorrect heart rate reading could result. In a commercial setting, space the products at least 24" apart. This will prevent cross-talk, where the chest strap signal from a user on one machine can be received and displayed on the console of another machine.
- Do not place the chest strap near devices that generate large magnetic fields. Television sets, electric motors, radios, and high voltage power lines can affect the transmitter's performance. These items can interfere with the heart rate signal that is being transmitted to the receiver, possibly affecting the heart rate readings that appear on the electronic console.
- Do not immerse the transmitter in water. However, some moisture is necessary for the transmitter to function properly. Perspiration is usually sufficient, but you may need to moisten the electrodes with a small amount of water. The electrodes are the ribbed portion on the side of the transmitter that sits against your skin.
- The wireless chest strap has a battery which may fail after a period of time. A faulty battery or worn electrodes may cause inaccurate readings. The electrodes are the ribbed portion on the side of the transmitter that sits against your skin. If the battery has failed, a new chest strap must be purchased.
- To purchase wireless transmitter straps, contact your dealer or Octane Fitness sales representative.

Some individuals are unable to use the heart rate feature because they do not have the proper body chemistry to provide accurate readings. If you experience difficulties in using the contact heart rate grips or a wireless chest strap, contact your dealer or Octane Fitness Customer Service at 1.888.OCTANE4.

**WARNING!** The heart rate monitoring features of this product are for information only and are *not* to be used as a measure of heart functioning or heart health. In a heart rate controlled program, you can use the Level controls to reduce the resistance level at any time. ***You are responsible for monitoring how you feel and adjusting the level of effort accordingly.*** If at any time during exercise you experience chest pains, nausea, dizziness, or shortness of breath, stop exercising immediately and consult a physician before starting again.

## POWERBAND SAFETY GUIDELINES

Before using the Powerbands with the Octane Fitness Q37ci, read and follow these instructions:

- Read owner's manuals and all warnings before use.
- **Securely attach** bands to machine before use.
- **Do not** clip multiple resistance bands together on the same handle.
- **Do not** store bands in stretched position for prolonged periods of time.
- Inspect bands and clips for signs of wear before use, discard if worn.
- **Do not** stretch bands more than 2 times original length.
- Use **caution** when stretching or releasing bands; uncontrolled release can cause serious injury.
- Detach Powerbands from machine after use.
- Keep children under the age of 13 away from Powerbands .
- Pull Powerband **from front of Octane elliptical mast ONLY** (as shown); do not pull Powerband from the side of the machine.
- Use **only** Octane Fitness Powerbands and grips with this Octane product.

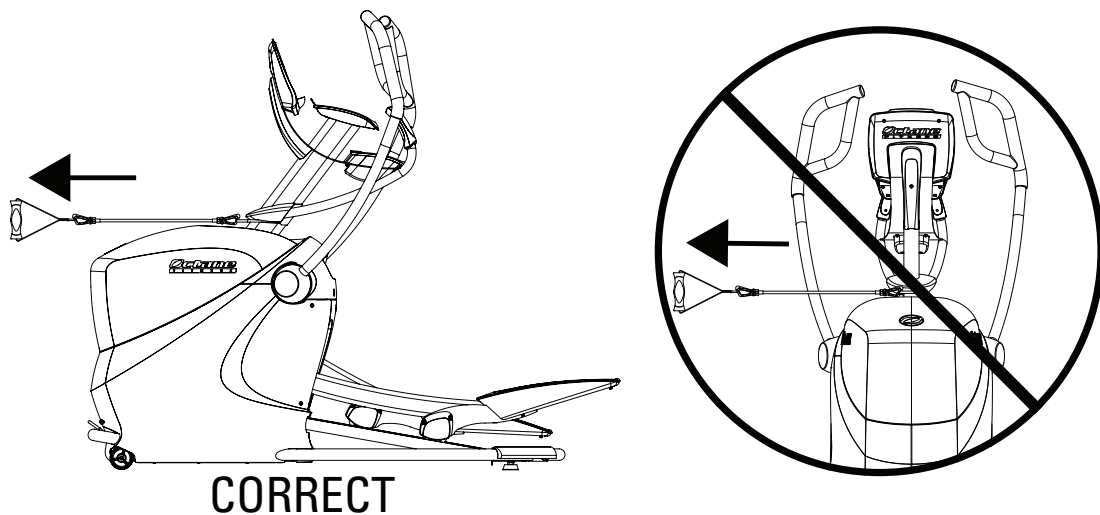

# Q37c/Q37ci PRODUCT LABELS

**⚠ WARNING**

Before starting any exercise program, consult your physician. Machine contains moving parts. To avoid injury keep children and pets clear of the exerciser at all times. Keep hands and feet clear during use. Review and follow all warnings and instructions in the owner's manual prior to use. Replace this label if damaged, illegible, or removed.

---

**⚠ WARNUNG**

Bevor Sie mit diesem Übungsprogramm beginnen, sollten Sie Ihren Arzt um Rat fragen. Maschine enthält bewegliche Teile. Um Verletzung zu vermeiden halten Sie Ihre Kinder und Haustiere durchgehend von der Maschine entfernt. Hände und Füße während des Gebrauches entfernt halten. Lesen und befolgen Sie alle Warnungen und Anweisungen in der Bedienungsanleitung vor Gebrauch. Ersetzen Sie dieses Label wenn es unleserlich ist, beschädigt oder entfernt wurde.

DEU

---

**⚠ AVERTISSEMENT**

Avant d'entamer un programme d'exercice, veuillez consulter votre médecin. L'appareil possède des parties mobiles. Pour éviter un accident, les enfants et les animaux domestiques doivent toujours être tenus à l'écart de la machine d'exercice. Gardez à l'écart les mains et les pieds pendant l'utilisation. Avant de vous servir de votre appareil, lisez et suivez tout avertissement et toutes consignes dans le manuel d'utilisateur. Remplacez ce label si elles sont endommagées, illisibles, ou enlevés.

FR-C

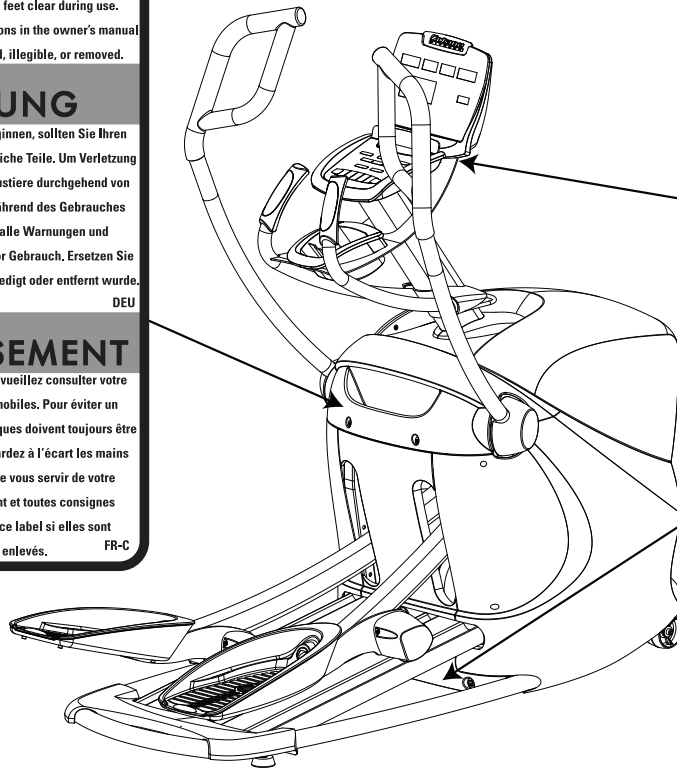

Console Serial Number  
(on lower edge)



Base Serial Number

**DO NOT REMOVE THIS LABEL  
DIESE ETIKETT NICHT ENTFERNEN  
NE PAS RETIRER CETTE ETIQUETTE**

---

**⚠ WARNING**

- READ owner's manual and all warnings before use.
- SECURELY ATTACH bands to machine before use.
- DO NOT clip multiple bands together on the same handle.
- DO NOT stretch bands to more than 2 times original length.
- Inspect bands and clips before use. Discard if there are any cuts, damage, or signs of wear.
- USE CAUTION when stretching or releasing bands; Uncontrolled release can cause serious injury.
- Detach bands from machine after use.
- Keep children aged 12 and under away from bands.
- Replace this label if damaged, illegible, or removed.

---

**⚠ WARNUNG**

- Bedienungsanleitung und alle Warnungen vor Verwendung LESEN.
- Bänder vor Verwendung FEST am Gerät BEFESTIGEN.
- NICHT mehrere Bänder am selben Handgriff befestigen.
- Bänder NICHT über die doppelte Länge der ursprünglichen Länge dehnen.
- Alle Bänder und Befestigungen vor Verwendung überprüfen. Ausrangieren, wenn Risse, Beschädigungen oder Abnutzungszeichen zu erkennen sind.
- VORSICHT beim Dehnen und Loslassen der Bänder; unkontrolliertes Loslassen kann zu schweren Verletzungen führen.
- Bänder nach Verwendung vom Gerät abnehmen.
- Kinder unter 12 Jahren von den Bändern fernhalten.
- Dieses Etikett ist zu ersetzen, wenn es beschädigt ist, nicht mehr lesbar ist oder entfernt wurde.

---

**⚠ AVERTISSEMENT**

- LIRE le Guide du propriétaire et tous les avertissements avant utilisation.
- FIXER SOLIDEMENT les bandes à l'appareil avant utilisation.
- NE PAS fixer plusieurs bandes à la même poignée.
- NE PAS étirer les bandes à plus de 2 fois leur longueur originale.
- Inspecter les bandes et les attaches avant utilisation. Les jeter si elles sont coupées, endommagées ou usées.
- FAIRE PREUVE DE PRUDENCE lors de l'étirement et du relâchement des bandes; un relâchement non contrôlé peut entraîner des blessures graves.
- Retirer les bandes de l'appareil après utilisation.
- Les enfants de 12 ans et moins ne doivent pas toucher, ni jouer avec les bandes.
- Remplacer cette étiquette si elle est endommagée, illisible ou si elle a été retirée.

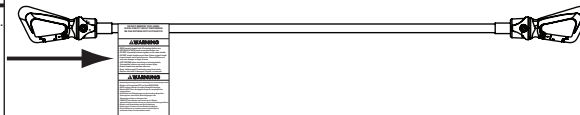

# TABLE OF CONTENTS

<b>Getting Started</b> .....	1
• <b>User Set-Up Functions</b> .....	1
• <b>Cleaning and Maintenance of the Q37 Series Elliptical</b> .....	3
• <b>Troubleshooting &amp; Frequently Asked Questions</b> .....	3
• <b>Warranty Information</b> .....	3
<b>Electronics</b> .....	4
• <b>Keypad Buttons</b> .....	4
• <b>Console Windows</b> .....	9
<b>Q37 Programs</b> .....	11
• <b>How Does Workload Resistance (Level) Work?</b> .....	11
• <b>What Are the CROSS CiRCUIT Programs?</b> .....	12
• <b>Q37 Settings—Value Ranges</b> .....	12
• <b>Q37 Program Reference</b> .....	13
<b>Q37 Product Features</b> .....	17
• <b>Heart Rate Monitoring and HeartLogic Intelligence</b> .....	17
• <b>MultiGrip Handlebars</b> .....	18

# GETTING STARTED

Get ready to Fuel Your Workout with the Q37c/Q37ci elliptical cross trainer by Octane Fitness! You will soon be challenging yourself with a variety of pre-programmed workouts, managed by sophisticated electronics that keep you interested and motivated. Getting started is easy—just step on and start pedaling. Follow the prompts to program your workout, and you are on your way!

## USER SET-UP FUNCTIONS

Program features, console settings, and controls of the Q37c/Q37ci can be adjusted to fit your personal preferences or workout environment. To access the User Set-up functions, press and hold both the Level (+) and Level (–) keys for three seconds, or until you hear a beep. The following customizable functions are displayed in sequence; use the Enter key to toggle through the available options for each function, and press any (+) or (–) key to select a setting and move to the next function. To exit without changing any values, press Pause Clear twice. Once saved, values become the new standard and do not need to be reset for each use.

<b>Warm-Up</b>	This feature may be turned “ON” (to include a 3-minute warm-up in each workout) or “OFF”. The factory default setting is “ON”.
<b>Pause</b>	Turning this function to “OFF” lengthens the period of time before a program automatically enters a parameter during programming to 10 minutes. The factory default setting is “ON”, which is the appropriate setting for a typical user. The “OFF” setting is primarily used during product demonstrations.
<b>Clock Direction</b>	The Q37 cross-trainer can track workout time by counting “UP” or “DOWN”. The factory default setting is “UP”.
<b>Movement Management (MOM)</b>	<p>MOM mode is a unique control feature offered on Octane Fitness ellipticals. Activating MOM mode disables the console buttons and increases the resistance in the movement of the pedals so that the pedals do not move as easily. This control feature may discourage children from experimenting with the machine.</p> <p>This User Set-Up function lets you enable (“On”) or disable (“OFF”) the MOM mode. The original setting is “On”. To activate MOM mode after your workout, press and hold the Program (+) and (–) keys for three seconds or until you hear the beep. The machine resistance then increases to level 20 and the console buttons are inactive. The machine appears to be in “Pause” mode, but if any console keys are pressed, “MOM MODE ACTIVE” scrolls across the matrix display. To unlock MOM mode, press and hold the Program (+) and (–) keys again for three seconds or until you hear the beep.</p> <p><b>CAUTION! MOM mode is a feature provided to reduce the likelihood that children can pedal the elliptical cross-trainer. This feature does not lock the machine; the pedals still move and the potential for injury still exists. It is the responsibility of the user to supervise children and keep them off the elliptical cross trainer to minimize the likelihood of injury.</b></p>
<b>Units</b>	You may choose to have the weight and distance units displayed in “ENGLISH” (pounds and miles) or “METRIC” (kilograms and kilometers). The factory default setting is “ENGLISH”.
<b>Beep</b>	You may turn the console sounds “ON” or “OFF”. The factory default setting is “ON”.
<b>30:30 Rest Minutes (Q37ci)</b>	You may set the 30:30 program rest time to 1, 2, or 3 minutes only. The original setting is 3 minutes.



<b>Brightness</b>	You can adjust the intensity or brightness of the console LEDs, choosing any value between 1 and 8. A higher number represents more light. The factory default setting is 8.
<b>Exit</b>	When EXIT is displayed, press Enter to leave User Set-up. All of your selections will be saved and become the new standard settings for your machine. They may be changed at any time by repeating these set-up procedures.
<b>Workout Boosters: X-Mode, GluteKicker, and ArmBlaster (Q37ci)</b>	
To customize the Workout Booster features, press and hold the X-Mode, GluteKicker, or ArmBlaster button for three seconds, or until you hear a beep. You can then customize the key characteristics of each booster. For each booster, once you have saved your selections, they are set as the new standard for your machine—you don't need to reset them for each use.	
<b>X-Mode On Time</b>	The length of each X-Mode interval. The original setting is 1:00. Use the Time (+) or (–) button to increase or decrease this interval (displayed in the TIME window), choosing any value between 0:15 and 10 minutes, in increments of 0:15. Press Enter to save the new X-Mode interval length. To exit without changing the value, press Pause Clear
<b>X-Mode Off Time</b>	The length of time between X-Mode intervals. The original setting is 1:00. Use the Time (+) or (–) button to increase or decrease this interval, choosing any value between 0:15 and 10 minutes, in increments of 0:15. Press Enter to save the new time between X-Mode intervals. To exit without changing the value, press Pause Clear.
<b>GluteKicker On Time</b>	The length of each GluteKicker interval. The original setting is 1:00. Use the Time (+) or (–) button to increase or decrease this interval (displayed in the TIME window), choosing any value between 0:15 and 10 minutes, in increments of 0:15. Press Enter to save the new GluteKicker interval length. To exit without changing the value, press Pause Clear
<b>GluteKicker Off Time</b>	The length of time between GluteKicker intervals. The original setting is 1:00. Use the Time (+) or (–) button to increase or decrease this interval, choosing any value between 0:15 and 10 minutes, in increments of 0:15. Press Enter to save the new time between GluteKicker intervals. To exit without changing the value, press Pause Clear.
<b>ArmBlaster Off Time</b>	The time between ArmBlaster sets. The original setting is 1:00. Use the Time (+) or (–) button to increase or decrease this interval (displayed in the TIME window), choosing any value between 0:15 and 10 minutes, in increments of 0:15. Press Enter to save the new time. To exit without changing the value, press Pause Clear.
<b>ArmBlaster Reps</b>	The number of repetitions in each ArmBlaster set. A press with both the right and left hand equals one rep. The original setting is 10. Use the Time (+) or (–) button to increase or decrease this number (displayed in the CALORIES window), choosing any value between 5 and 20. Press Enter to save the new number of reps. To exit without changing the value, press Pause Clear.
<b>ArmBlaster Level Change</b>	The number of resistance levels to be added to your cardio level for the ArmBlaster “blasts”. The original setting is 10. Use the Level (+) or (–) button to increase or decrease value (displayed in the CALORIES window), choosing any value between 1 and 19. Press Enter to save the new level change value. To exit without changing the value, press Pause Clear.

## Cleaning and Maintenance of the Q37 Series Elliptical

**WARNING!** This machine contains moving parts. Take caution when trying to locate and fix any problem with the machine.

Your Octane Fitness elliptical has been manufactured to withstand many hours of hard use with minimal required maintenance. Simply wipe off the machine with a clean towel after a hard workout to remove any sweat to keep the machine clean. ***Do not use bleach on the console as it will damage the surface.***

Use a clean towel with a mild soap and water solution to clean tracks and rollers and the Powerband handles after use. Powerbands may be cleaned with Armor All® or a similar cleaning product to restore the original shine.

Please contact your local Octane Fitness dealer should you have any questions or encounter any maintenance issues with your Q37. If you would like to speak directly to an Octane Fitness customer service specialist, please call 888.OCTANE4 or 763.757.2662, ext. 1, or visit [www.octanefitness.com](http://www.octanefitness.com).

## Troubleshooting & Frequently Asked Questions

Should you have any questions regarding your Q37 elliptical, please log on to [www.octanefitness.com](http://www.octanefitness.com) where you will find answers to many common questions and tips on using your elliptical. If you would like to speak to an Octane Fitness Customer Service specialist, please call 1-888-OCTANE4 or 763-757-2662 extension 1.

## Warranty Information

The Q37 elliptical is warranted to be free of all defects in material and workmanship for a specific period of time from original date of purchase. Please refer to the Octane Fitness Limited Consumer Warranty included in your information packet for full terms and details of warranty coverage.

# ELECTRONICS

The Q37c/Q37ci features a simple, easy to understand keypad and a console which includes a workout profile matrix and four multi-function LED display windows that provide all the information you need to get started and stay motivated during your workout. Check out the program descriptions found later in this manual to choose the workout that is just right for you.

Getting started is easy—just hop on and start pedaling. DedicatedLogic™ programming gives you the ultimate in ease of use and total flexibility for programming your console. This allows you to modify your workout once you've started. You can even start your workout, then program the electronics. This ease of use starts by giving each key only one function. This makes it easy to understand how each key works.

## Keypad Buttons

### Quick Start

The easiest way for you to start your workout is to simply push the Quick Start button, setting the machine in a manual program at resistance level one. The calories readout will be based on a 150 lb. (68 kg) user, age 40. Once you have selected Quick Start, you can program any item in any order.

### My QuickStart 1 & My QuickStart 2 (Q37ci)

The My QuickStart buttons take Quick Start to the next level by memorizing your workout profile. My QuickStart remembers your favorite program and attributes and, with a simple push of the button, retrieves them for your next workout.

You can easily set your profile while using the machine. Simply begin your workout and enter your information as usual—program, time, level, weight, and age (Q37ci only), adding ArmBlaster, X-Mode, and/or GluteKicker if you wish. Once your elliptical cross trainer is set the way you like it, simply press and hold the My QuickStart 1 (or My QuickStart 2) button until you hear the console beep, indicating that this favorite profile has been saved. If you decide during your workout to change what you have saved (for example, you decide to increase the time or level), just enter the changes on the console. If you want to save these new settings, just press and hold My QuickStart again for three seconds or until you hear the beep. This resets your saved profile using the new attributes.

The next time you are ready for your favorite workout, simply press the My QuickStart button and begin pedaling. You may also switch to your favorite program after you have started a workout; to do this, press Pause Clear twice within two seconds to reset the machine, then press My QuickStart to begin your program.

**Tip:** Use My QuickStart 1 and My QuickStart 2 to save two different workouts. Save the first one according to the directions above, then press Pause Clear twice within two seconds to reset the machine, and follow the steps again to save the second workout using the other My QuickStart button. If you feel like doing something different after you have started your favorite workout with My QuickStart, simply enter your new information. This will only change the current workout, not your saved favorite.

**Tip:** View total workout statistics for these favorite workouts at any time by pressing and holding My QuickStart 1 or My QuickStart 2 and Enter for 3 seconds.

### Now-Zone (Q37ci)

Press the Now-Zone button to move instantly into a heart rate-controlled program using your current heart rate as the target. Press the button a second time to exit the heart rate-controlled program and enter a manual program. Now-Zone can be activated while in any program at any time as long as you are wearing your wireless transmitter.

# Q37c Console and Keypad

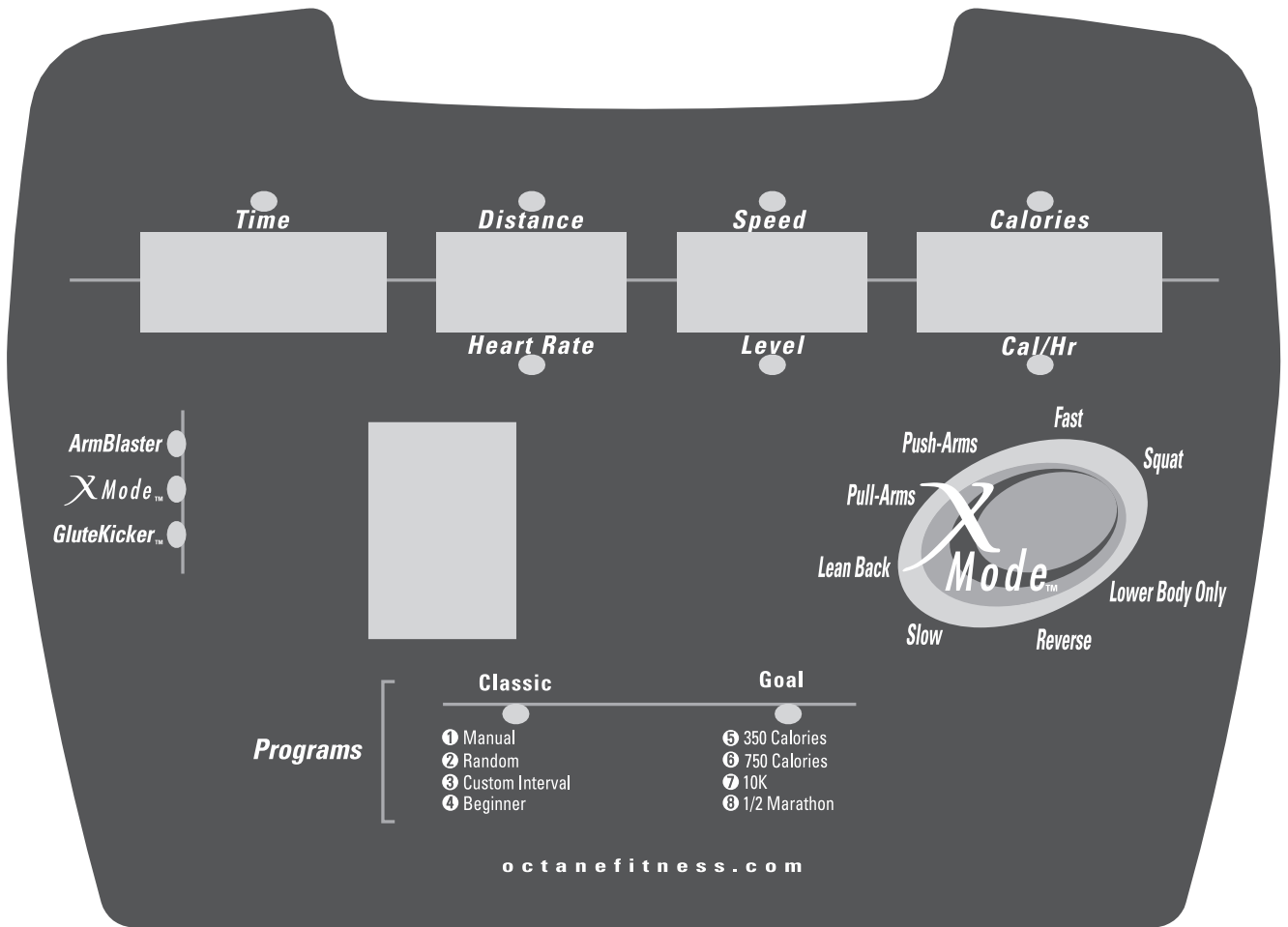

# Q37ci Console and Keypad

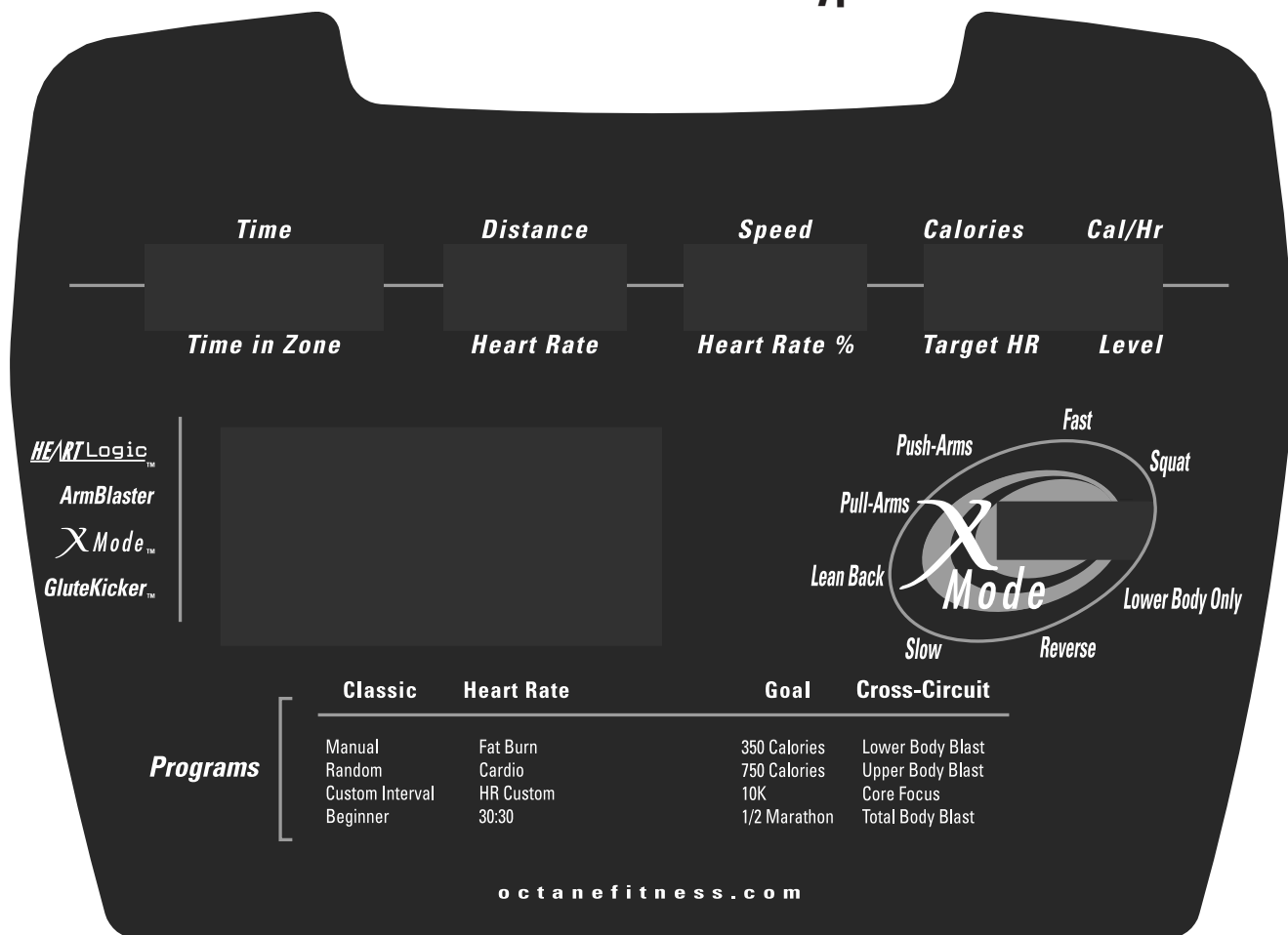

## Cool Down

It is always a good idea to perform a cool-down at the end of your routine. This will help transition your body from an aggressive workout to its normal pace. The time and intensity of the cool-down is automatically customized to your workout duration and resistance level. The time window will change to a countdown timer to tell you how long the cool-down will last.

If you have set a time for your workout, the cool-down will automatically start when time has expired. If you decide to end your workout early or have not set a time goal, simply push the Cool Down button to activate the custom cool-down. At the completion of your cool-down a workout summary will be displayed.

## Pause Clear

Press once to pause your workout. The standard pause time is 5 minutes. Use the Time (+) or (–) keys to increase or decrease the pause time; this adjustment can be made at any time while the machine is in pause mode. To restart a paused workout, push any key or just begin pedaling. If you stop pedaling during a workout, the unit will automatically begin a pause phase; simply start pedaling to resume your workout.

Press the Pause Clear button twice within two seconds, and your machine is reset and ready for another workout. Press and hold the Pause Clear button until you hear the beep to enter sleep mode, a virtual off mode. The matrix display reads “UNFUELING”, and just one LED in the X-Mode window remains lit. Your elliptical requires very little power in this mode. To “wake” your elliptical, simply press any button or begin pedaling.

## Up and Down Keys

### Time

Press the Time (+) or (–) to increase or decrease the time of your workout, in 1 minute increments. The standard workout time is 30:00. The maximum time is 99:00.

### Program

Press the Program (+) or (–) to scroll through the programs, then press Enter to select a program. Program changes can be made any time during your workout. When you change programs, the matrix window prompts you to enter new program values as needed.

**Note:** The Program (+) or (–) keys are also used to activate the MOM (MOvement Management) motion control feature of the Octane Fitness elliptical.

### Level

Press Level (+) or (–) to increase or decrease the resistance level of the machine. There are 20 levels of resistance for preset resistance programs and the 30:30 fitness number program. For heart rate controlled programs, the Level button increases your target heart rate. To save a change in target heart rate, press Enter.

### Age (Q37c)

Press Age (+) or (–) to enter the age to be used by heart rate programs on the Q37ci. The program calculates a recommended target heart rate based on the formula  $(220 - \text{age}) = \text{theoretical maximum heart rate (TMHR)}$ . That number is then multiplied by the program intensity value to determine your target heart rate(s).

### Weight

Press Weight (+) or (–) to increase or decrease the value for user weight. This value is used to give a more accurate calorie burn readout. Weight is displayed in pounds (English) or kilograms (metric); use the User-Set up functions to change the display units.

### Enter

Selects any of the changed values or items from the above keys. Also, pressing the Enter key during any workout will stop the LED readout windows from toggling between display modes.

**Note:** The Q37c/Q37ci has an intelligent sleep mode—a virtual off button. To enter sleep mode, press and hold the Pause Clear button until you hear the beep. The matrix display reads “UNFUELING”, and just one LED in the X-Mode window remains lit. Your elliptical requires very little power in this mode. To “wake” your elliptical, simply press any button or begin pedaling.

## Workout Boosters

### ArmBlaster

ArmBlaster is a proprietary program designed to boost cardiovascular endurance while building strength and muscle tone. Press the ArmBlaster button at any time during your workout to integrate cardio sessions with strength sessions. The cardio session follows the program profile that you have selected. Every minute, resistance increases for a muscle-building, 10-repetition set as you transfer the workload from your lower body to your upper body. During the ArmBlaster rep countdown, the level of resistance can be changed by pressing any (+) or (–) keys. To deactivate ArmBlaster, press the ArmBlaster button a second time.

**Tip:** If your Q37 is equipped with the optional CROSS CiRCUIT+ stationary foot platforms, step onto the platforms during your ArmBlaster sessions for an even more intense upper-body challenge.

### X-Mode

Press X-Mode to activate the ultimate cross training tool and take advantage of the variety your elliptical cross trainer offers. This great motivational tool keeps your workout fresh and exciting in any program. Every other minute X-Mode kicks in, prompting you to perform combinations of eight different challenges:

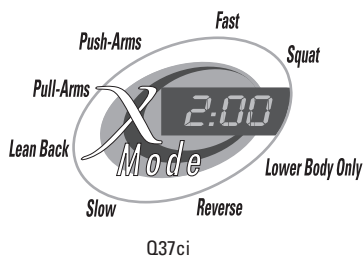

#### Fast

Pick up the pace—we recommend 50-60 rpm, but you should find your own comfort level.

#### Squat

Bend slightly at the knees. You'll feel this one in your quadriceps and glutes in no time!

#### Reverse

Pedal backwards to change the muscle focus on your entire lower body.

#### Lean Back

Grab the stationary handlebars and lean slightly backwards, changing the muscle focus on your lower body. You will feel this in your quadriceps.

#### Lower Body Only

Either hold the stationary handlebars or naturally swing your arms.

#### Push-Arms

Focus on pushing with your arms to work your chest and triceps.

#### Pull-Arms

Focus on pulling with your arms to work your biceps and lats.

#### Slow

Slow down to 30-40rpm to allow yourself to recover.

During an X-Mode session, the level of resistance can be changed by pressing any (+) or (–) keys on the keypad or the right handlebar. Deactivate X-Mode by pressing the button a second time.

### GluteKicker

GluteKicker is an aggressive subset of X-Mode that is focused on your glutes, hips, and thighs. It uses four prompts: **Reverse**, **Squat**, **Fast**, and **Lean Back**. GluteKicker sessions last for one minute, with a one-minute recovery period. During the GluteKicker session, the level of resistance can be changed by pressing any (+) or (–) keys on the keypad or the right handlebar. Deactivate GluteKicker by pressing the button a second time.

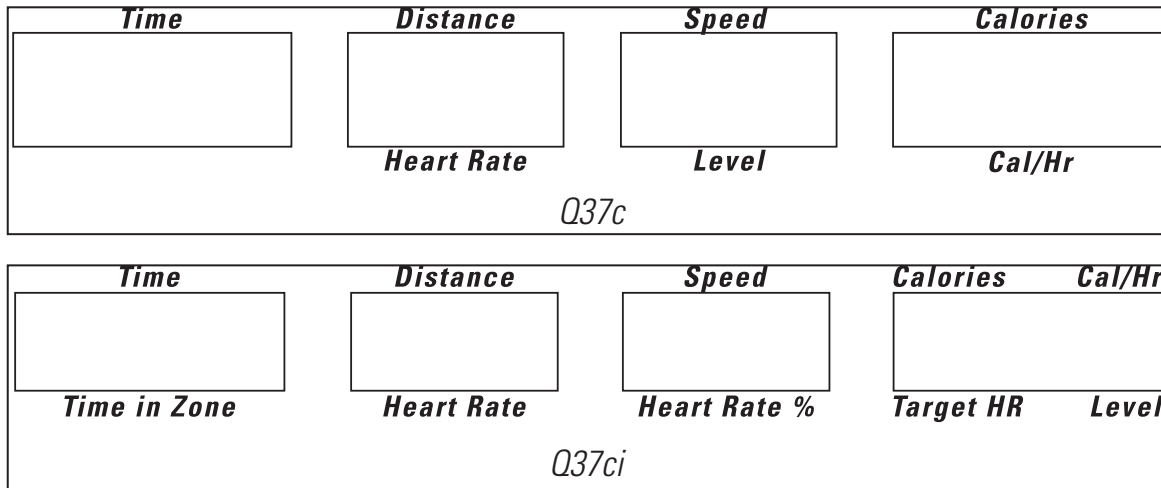

## Console Windows

### Matrix Display

The Q37 matrix display prompts you to enter important information, shows the program profile during the workout and highlights upcoming intervals and resistance changes. Watch the matrix display as you set up and progress through your workout—it will guide you, motivate you, and reward you with summary information at the end of your session.

**Changing Target Heart Rates:** When you are trying to reach a new target heart rate, the left side of the matrix display shows an illustration of the interval. The illustration blinks the interval you are attempting to reach. Each column represents one minute. An arrow on the right side of the display shows whether resistance (and therefore your target heart rate) is increasing or decreasing. When decreasing, if the machine reaches resistance level 1 and your heart rate has still not reached your target low, the display prompts you with the message "HR TOO HIGH—SLOW DOWN". When increasing, if the machine reaches the highest resistance level (20) and your heart rate has still not reached your target high, the display prompts you to "INCREASE SPEED TO DECREASE RESISTANCE".

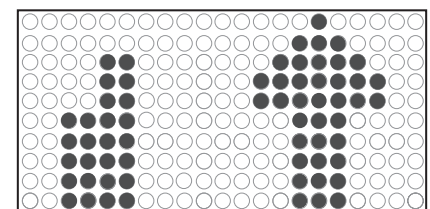
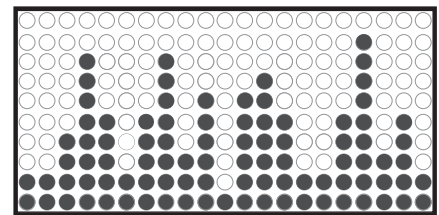

← **Upcoming columns blink**

**Interval Duration:** Once you have reached or surpassed the new target heart rate, the matrix display switches to a countdown timer, counting down the length of the interval. The bottom row of the matrix displays a horizontal bar graph representing the current resistance level.

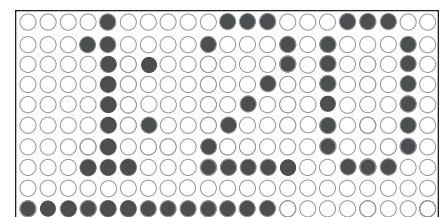



<b>Time</b>	Displays workout time, counting up from 0:00. Time can be increased or decreased during your workout. The maximum time that users can set is 99:00. When actual workout time is displayed, the timer goes up to 99:59, then the display rolls over to 0:00. Refer to User Set-up Functions to learn how to switch from a “count up” to “count down” display.
<b>Distance</b>	Displays an estimate of how far you have traveled. Distance can be shown in either miles (English) or kilometers (metric). When you first purchase your elliptical the display will be in English. Refer to User Set-up Functions to learn how to switch from English to metric. <b>Note:</b> <i>On the Q37, 400 revolutions is approximately one mile; therefore, if you are pedaling at 50 rpm, you will “travel” approximately one mile in 8 minutes.</i>
<b>Speed</b>	Displays how fast you are going, in revolutions per minute (rpm).
<b>Calories</b>	Displays an estimate of the total calories burned during the workout, based on the user’s entered weight. If no specific weight is entered, calories are based on a 150 lb. (68 kg) user.
<b>Cal/Hr</b>	Displays the number of calories that would be burned in one hour at the current resistance level and speed.
<b>Time-in-Zone (Q37ci)</b>	Tracks and displays the amount of time spent in the proper heart rate training zone for the program on the Q37ci. Time-in-Zone is only displayed in a heart rate controlled program when a heart rate is detected by the machine. <b>Note:</b> <i>You must be wearing a wireless heart rate transmitter or consistently grasping the contact heart rate sensor grips on the stationary handlebars in order to get an accurate reading of Time-in-Zone.</i>
<b>Heart Rate</b>	Displays heart rate in beats per minute (BPM). <b>Note:</b> <i>You must be wearing a wireless heart rate transmitter or consistently grasping the contact heart rate sensor grips on the stationary handlebars.</i>
<b>Heart Rate % (Q37ci)</b>	Displays your current heart rate percentage (current heart rate / theoretical maximum heart rate). <b>Note:</b> <i>You must have entered your age and be wearing a wireless heart rate transmitter or consistently grasping the contact heart rate sensor grips on the stationary handlebars in order to get an accurate reading of Heart Rate %.</i>
<b>Target HR (Q37ci)</b>	Displays the heart rate reading that the machine is adjusting resistance to achieve when in a heart rate controlled program on the Q37ci. In these programs, the machine adjusts resistance level in response to your heart rate in order to achieve this target.
<b>Level</b>	Displays the resistance level (1-20), where 1 is the lowest resistance level and 20 is the highest.

# Q37 PROGRAMS

The **Q37c** has 8 built-in programs to keep your workouts interesting:

Classic programs: Manual—Random—Custom Interval—Beginner  
Goal programs: 350 Calories—750 Calories—10K—1/2 Marathon

The **Q37ci** with wireless heart rate includes an additional 8 programs to further challenge and motivate:

Heart rate programs: Fat Burn—Cardio—HR Custom Interval—30:30  
Cross-Circuit programs: Lower Body Blast—Upper Body Blast—Core Focus—Total Body Blast

Programs begin with a warm-up to ease your body into your intense workout. During the warm-up, the resistance increases each minute. At the end of the warm-up, you will be at your selected resistance value or target heart rate. You can change the level at any time during the warm-up.

Choose the program that best fits your workout needs for any given day. You decide how hard to work by setting the resistance level and goal (such as time, distance, or calories). Program your workout your way!

## How Does Workload Resistance (Level) Work?

### Resistance Level

The Q37 has 20 discrete levels of resistance. Level 1 is the easiest and level 20 is the most difficult. The Manual and CROSS CiRCUIT programs and Quick Start give you the ability to totally control the resistance level; the level changes only if you use the Level (+) or (–) keys to do so. Interval Programs (Custom Interval and 30-30) allow the user to select the resistance level for specific intervals.

For all programs except the Goal Programs, resistance level is represented by rows of LEDs in the matrix display. Each row that is lit represents 2 resistance levels. The table below will help you understand and interpret the matrix display:

Resistance Levels	LED Rows Lit	Resistance Levels	LED Rows Lit
1-2	1	11-12	6
3-4	2	13-14	7
5-6	3	15-16	8
7-8	4	17-18	9
9-10	5	19-20	10

### Program Level

The Random program and Goal programs using the ‘Hills’ profile let you select an overall resistance level for the program. This level is the average resistance level for the workout. The range of resistance levels during these workouts are plus (+) or minus (–) 4 of the entered program level. That is, for program Level 5, minimum resistance is Level 1 and maximum resistance is Level 9. During the workout, the overall program resistance level is displayed. You can change the Level at any time.

### Resistance in Heart Rate Controlled Programs

These programs (Fat Burn, Cardio, Heart Rate Custom Interval) allow you to manually enter the target heart rate level for program. If the target HR is reached during the warm-up, the warm-up ends and the selected heart rate control program begins. The resistance level during the heart rate controlled workout is controlled by the machine, increasing or decreasing as necessary to keep your heart rate on target.

You choose the program that best fits your workout needs for any given day. You can decide how hard to work by setting the resistance level and time for each program. Four programs—Manual, Custom Interval, Custom Heart Rate Interval—provide great flexibility to program individual workouts to meet specific needs.

Use the quick-reference chart on the following pages to help select and set up the programs. Program your workout your way!

## What Are the CROSS CiRCUIT Programs?

CROSS CiRCUIT is a whole new way of working out with your Octane elliptical. These programs on the Q37ci combine cardio intervals on the elliptical cross trainer with sets of strength and toning exercises off the machine using simple equipment such as hand weights or a fitness ball, or the optional CROSS CiRCUIT foot platforms and Powerbands.

Your CROSS CiRCUIT Strength Training Interval Guide provides suggested exercises to target the lower body (green tab), upper body (blue tab), and core (red tab). Just choose the exercises that best suit your needs. Mix it up, keep it interesting, and watch your body change for the better with these great total-body workout alternatives!

### Powerbands

Your Q37ci comes with two Powerbands to help you get started with your CROSS CiRCUIT strength training. The Powerbands should be attached at the anchor points as shown.

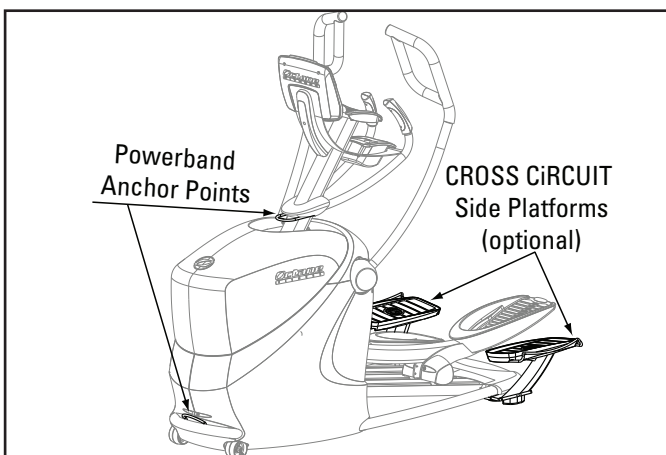

**Note:** When using the Powerband at the anchor point on the mast, pull from front of machine ONLY; do not pull the Powerband from the side of the machine.

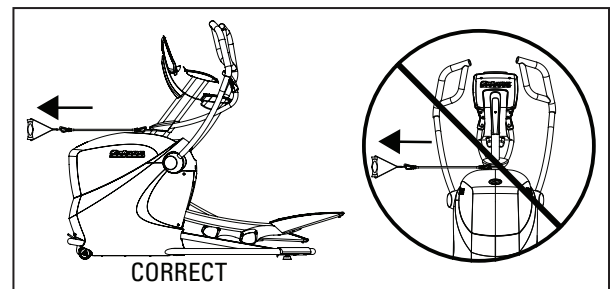

Additional Powerbands and stationary foot platforms are available in the CROSS CiRCUIT<sup>+</sup> Kit. Contact Octane Fitness Customer Service for purchase details and availability.



Q37 SETTINGS—VALUE RANGES			
Setting	Standard Values*	Minimum Value	Maximum Value
Workout Time	30:00	1:00	99:00
Level	1	1	20
Age	40	15	99
Weight	150 lbs. (68 kg)	70 lbs. (32 kg)	300 lbs. (181 kg)
Interval Time	00:30	00:15	99:00
Interval Level	1	1	20
How Many Intervals	3	2	6
Target Heart Rate	(220 - Age) * %; varies by program	80	(220 - Age)
Calorie Goal	350 or 750	25	2000
Distance Goal	6.2 miles (10K) or 13.1 Miles (21K)	.25 miles (.4 km)	50 miles (80 km)
Flat or Hills?	Flat	n/a	n/a
Cardio Time	2:00	1:00	30:00
Strength Time	1:00	0:15	30:00

\*Standard program values are used if no values are entered within 4 seconds of Message Center prompts.

# 037 PROGRAM REFERENCE

Press Program (+) or (-) and Enter to choose a program.

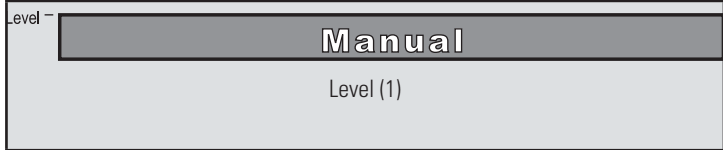
## CLASSIC PROGRAMS

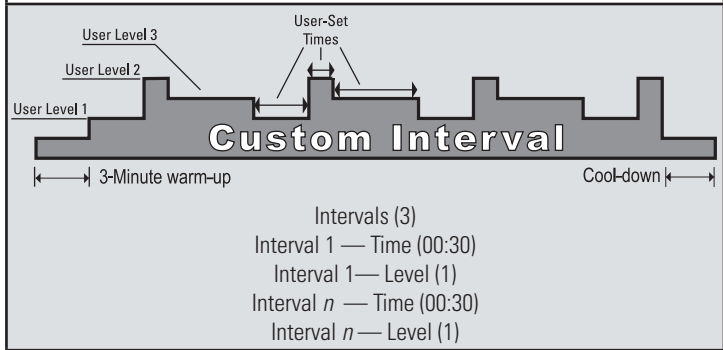
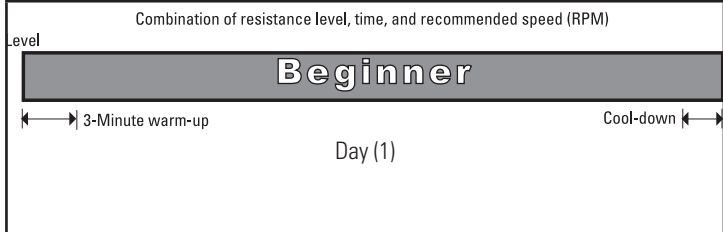
Programs & Standard Settings	Description
	<p>Get on and go; constant resistance simulates walking or jogging on a flat surface. The oval racetrack equals 1/4 mile (or 400 meters); the counter in the matrix display shows laps completed.</p>
	<p>Enjoy computer-randomized resistance variation with a virtually infinite number of combinations. Get a new course each time you select the program or change the level. Each interval lasts one minute.</p>
	<p>Design a custom workout of up to 6 alternating intervals of user-defined duration and resistance. Use Level (+) or (-) to adjust interval resistance mid-workout.</p>
	<p>Follow a 14-day planned workout sequence to help jump-start your exercise program. Each day's workout includes preset values for resistance level, time and a suggested speed (RPM). The values gradually increase in intensity each day, building up your stamina and getting you ready to workout on your own. Use Level (+) or (-) to chose the day (1-14) and you're ready to go!</p>

## GOAL PROGRAMS

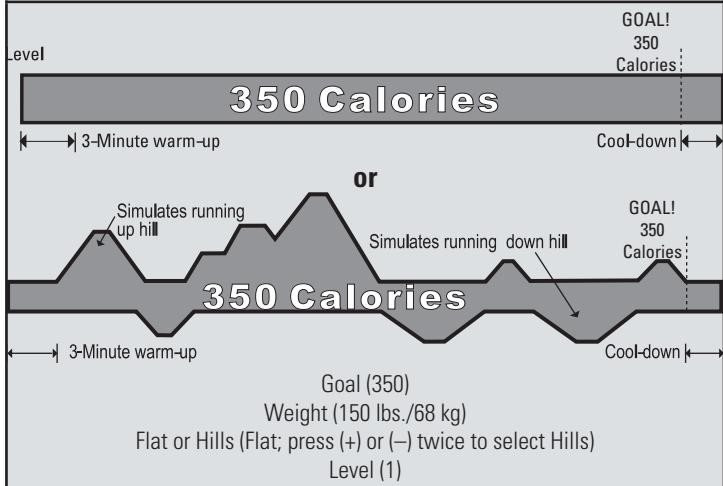
Programs & Standard Settings	Description
	<p>Get moving on a flat or 'hilly' course until you have burned 350 calories. Use Level (+) or (-) to adjust interval resistance mid-workout. Watch the calories fall away!</p> <p><i>Note:</i> To select "hills", press any (+) or (-) twice while "FLAT OR HILLS" is displayed, then press ENTER.</p>

# Q37 PROGRAM REFERENCE

Press Program (+) or (-) and Enter to choose a program.

Level

**750 Calories**

3-Minute warm-up

Simulates running up hill

or

Simulates running down hill

GOAL! 750 Calories

Cool-down

GOAL! 750 Calories

3-Minute warm-up

Cool-down

Goal (350)  
Weight (150 lbs./68 kg)  
Flat or Hills (Flat; press (+) or (-) twice to select Hills)  
Level (1)

For an even greater challenge...work the course until you have burned 750 calories. Use Level (+) or (-) to adjust interval resistance mid-workout. Complete this program and you will know you've had a great workout!

Note: To select "hills", press any (+) or (-) twice while "FLAT OR HILLS" is displayed, then press ENTER.

Level

**10K**

3-Minute warm-up

Simulates running up hill

or

Simulates running down hill

GOAL! 10K

Cool-down

GOAL! 10K

3-Minute warm-up

Cool-down

Goal (6.2 mi./10K)  
Flat or Hills (Flat; press (+) or (-) twice to select Hills)  
Level (1)

Complete a virtual 10K—a great way to train for an actual event. Choose a flat course or take to the hills as gradual resistance changes simulate variance in terrain, replicating the challenges encountered when walking or running outside. The distance readout counts down from 6.2 miles (10 kilometers). Use Level (+) or (-) to adjust interval resistance mid-workout.

Note: To select "hills", press any (+) or (-) twice while "FLAT OR HILLS" is displayed, then press ENTER.

Level

**1/2 Marathon**

3-Minute warm-up

Simulates running up hill

or

Simulates running down hill

GOAL! 1/2 Marathon

Cool-down

GOAL! 1/2 Marathon

3-Minute warm-up

Cool-down

Goal (13.1 mi./21K)  
Flat or Hills (Flat; press (+) or (-) twice to select Hills)  
Level (1)



Get ready for the long run as you tackle the 1/2 marathon. Choose the flat or 'hilly' course and watch the miles fall away as the distance readout counts down from 13.1 miles (21 kilometers). Use Level (+) or (-) to adjust interval resistance mid-workout.

Note: To select "hills", press any (+) or (-) twice while "FLAT OR HILLS" is displayed, then press ENTER.

# Q37 PROGRAM REFERENCE

Press Program (+) or (-) and Enter to choose a program.

## Q37ci HEART RATE PROGRAMS

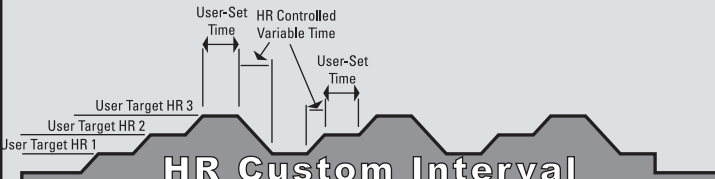
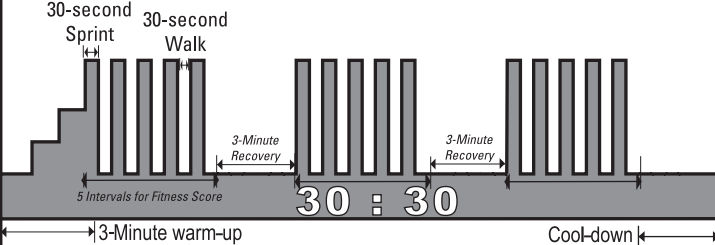
Programs & Standard Settings	Description
 <p><b>Fat Burn</b></p> <p>65%</p> <p>Variable warm-up Cool-down</p> <p>Age (40) Target Heart Rate (.65 * (220 - Age))</p>	<p>Maximize the percentage of calories burned from fat versus carbohydrates with this controlled workout at 65% of theoretical maximum heart rate (or user-specified target heart rate). Use Level (+) or (-) to adjust interval target heart rates mid-workout.</p>
 <p><b>Cardio</b></p> <p>80%</p> <p>3-Minute warm-up Cool-down</p> <p>Age (40) Target Heart Rate (.80 * (220 - Age))</p>	<p>Maximize cardiovascular benefits with this controlled workout at 80% of theoretical maximum heart rate (or user-specified target heart rate). Use Level (+) or (-) to adjust interval target heart rates mid-workout.</p>
 <p><b>HR Custom Interval</b></p> <p>User-Set Time HR Controlled Variable Time User-Set Time</p> <p>User Target HR 3 User Target HR 2 User Target HR 1</p> <p>Variable warm-up Cool-down</p> <p>Age (40) Intervals (3) Interval 1 — Time (00:30) Interval 1 — Target Heart Rate (.75* (200 - Age)) Interval n — Time (00:30) Interval n — Target Heart Rate (.75* (200 - Age))</p>	<p>Build a custom heart-rate controlled workout of up to 6 alternating intervals of user-defined duration and target heart rates. Use Level (+) or (-) to adjust interval target heart rates mid-workout.</p>
 <p>30-second Sprint 30-second Walk</p> <p>3-Minute Recovery 3-Minute Recovery</p> <p>5 Intervals for Fitness Score</p> <p><b>30 : 30</b></p> <p>3-Minute warm-up Cool-down</p> <p>High Interval Level (8)</p>	<p>This challenging program provides a simple test of fitness level with 5 sets of 30-second sprint and recovery intervals. For each set, the program monitors heart rate and calculates the average minimum and average maximum heart rates and the average number of beats the heart rate recovers between sprint intervals. Heart rate recovery is a relative indicator of fitness level; a higher number indicates a more rapid heart rate recovery and therefore represents a relatively better level of fitness.</p>

# Q37 PROGRAM REFERENCE

Press Program (+) or (-) and Enter to choose a program.

## Q37ci CROSS CiRCUIT™ PROGRAMS

(Refer to your CROSS CiRCUIT Strength Training Interval Guide for suggested exercises.)

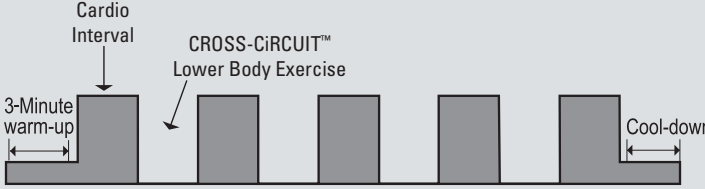
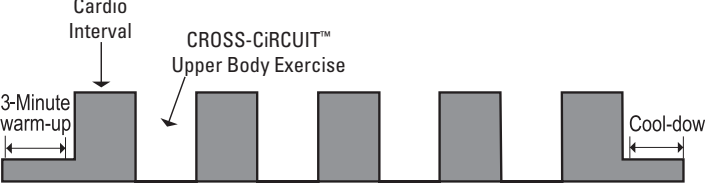
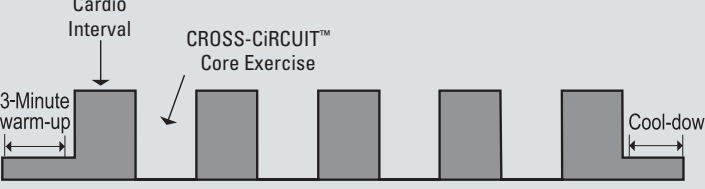
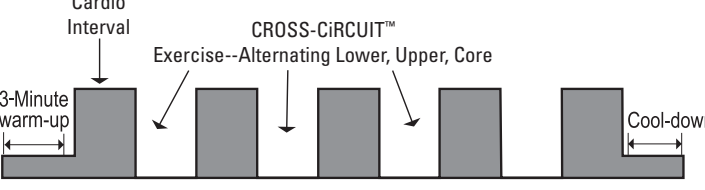
Programs & Standard Settings	Description
 <p style="text-align: center;"><b>Lower Body Blast</b></p> <p style="text-align: center;">Cardio Time (2:00) Strength Time (1:00) Level (1)</p>	<p>Target the thighs, calves, hips and glutes with off-machine strength-building sets. Set up the Cardio Time, Strength Time, and Level, complete your warm-up, then listen for the beeps to tell you when to step off the machine to complete your lower-body strength set. The display will flash and you will hear another set of beeps when it is time to step back on the elliptical for your next cardio interval. This pattern continues throughout your workout. Use Level (+) or (-) to adjust the cardio interval resistance mid-workout.</p>
 <p style="text-align: center;"><b>Upper Body Blast</b></p> <p style="text-align: center;">Cardio Time (2:00) Strength Time (1:00) Level (1)</p>	<p>Target the arms, shoulders, chest, and upper back as you follow the prompts to complete alternating sets of on-machine cardio routine and off-machine strength exercises. Use Level (+) or (-) to adjust the cardio interval resistance mid-workout.</p>
 <p style="text-align: center;"><b>Core Focus</b></p> <p style="text-align: center;">Cardio Time (2:00) Strength Time (1:00) Level (1)</p>	<p>Target the abs and back with this challenging on- and off-machine workout. Follow the prompts to complete alternating sets of cardio and strength exercises. Use Level (+) or (-) to adjust the cardio interval resistance mid-workout.</p>
 <p style="text-align: center;"><b>Total Body Blast</b></p> <p style="text-align: center;">Cardio Time (2:00) Strength Time (1:00) Level (1)</p>	<p>Work it all with exercises aimed at strengthening and toning your entire body. A pattern of upper, lower, and core off-machine strength sets continues throughout your workout. Use Level (+) or (-) to adjust the cardio interval resistance mid-workout.</p>

\*Standard program values are used if no values are entered within 4 seconds of Message Center prompts.

# Q37 PRODUCT FEATURES

The Octane Fitness Q37 elliptical incorporates additional features to ensure that you experience great workouts, including HeartLogic Intelligence and MultiGrip Handlebars. In addition, many of the standard features and controls of your Octane Fitness elliptical can be customized to fit your personal preferences or workout environment.

## Heart Rate Monitoring and HeartLogic Intelligence

The Q37c and Q37ci ellipticals are equipped with state-of-the-art heart rate monitoring and control technologies that help you make the most of your training efforts. Both models include on-demand heart rate monitoring—just grasp the digital contact heart rate grip sensors on the stationary handlebars and your current heart rate is displayed on the console.

For even greater control of your workout, the Q37ci is also equipped with HeartLogic Intelligence, Octane Fitness' sophisticated yet easy to use heart rate control technology. This sophisticated solution provides the most accurate and effective workout possible using heart rate data captured by a wireless chest strap or the digital contact heart rate grip sensors on the stationary handlebars.

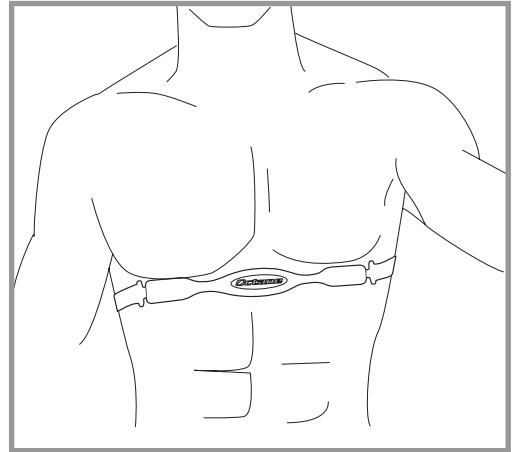

The Q37ci features premium workouts designed to take full advantage of the benefits of heart rate zone training: Fat Burn, Cardio, Heart Rate Custom Interval, and 30:30. The console displays time-in-zone, current heart rate, heart rate %, and target heart rate so you know exactly where you are and where you should be.

### **Using a wireless chest strap** *(Q37ci)*

The wireless chest strap transmits your heart rate to the electronics console at a distance of up to three feet. You may use any Polar™-compatible (coded or non-coded) transmitter. Adjust the length of the elastic strap and fasten the transmitter around your torso, underneath your shirt. Place the strap just below your chest. Make sure the logo is away from you and right side up. It may help to moisten the electrodes on the back of the transmitter with a small amount of water for better contact with the skin. The electrodes are the ribbed portion on the back side of the transmitter that sits against your skin. Make sure the strap fits snugly but doesn't restrict breathing. The contact handgrips reading takes priority if both the wireless and contact heart rate grips are in use.

### **Using the digital contact heart rate sensors**

The digital contact heart rate sensors are located on the stationary handlebars of the Q37c and Q37ci. The grips can be used to check your heart rate during your workout. For the most accurate heart rate reading possible, grasp each contact heart rate grip so that the contact sensor portion of the grip rests in the palm of your hand. Grip the contact sensors firmly, and keep your hands steady and in place.

### **Heart rate programs** *(Q37ci)*

The Q37ci provides three different heart rate controlled programs (Fat Burn, Cardio, and Heart Rate Custom Interval) to offer you more variety to suit your personal needs. The 30:30 program also uses heart rate data to provide an assessment of heart rate recovery. We recommend that you try different programs to determine your favorite. Refer to the Q37 Program Reference chart for more information.



## MultiGrip Handlebars

Your Octane Fitness cross trainer features one-of-a-kind handlebars that deliver the ultimate upper-body workout with virtually unlimited options for maximal comfort, customization, and effectiveness. The unique MultiGrip handlebars with converging motion are only offered by Octane, and these innovative handlebars have revolutionized how you workout your upper-body. The MultiGrip handlebars are comfortable in any position, whether you're hanging on loosely for a brief, easy workout, or gripping them tightly to complete a lengthy, heart-pumping, high-intensity workout session.

The converging motion and unique design of the MultiGrip handlebars fit every exerciser—tall, short, slender, large-framed, and even those with shorter or longer arms—providing a multitude of choices that result in the most comfortable and ergonomically correct positions of any cross trainer. You will feel the difference! Here's how they can be put to work for you:

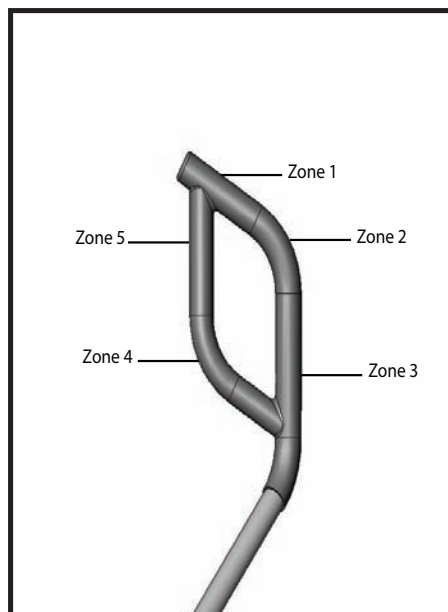

Zone 1	Top horizontal position	Ideal for pushing Gives longer range of motion Engages the deltoid (shoulder) and lat (back) muscles
Zone 2	Large corner position Widest position	Push with the palms; better stability for a excellent chest press motion Focuses more on using the pectoral (chest) muscles
Zone 3	Wide grip	Emphasizes pectoral (chest) and lat (back) muscles
Zone 4	Low inside position	Shorter range of motion Suitable for lighter workouts with less upper-body involvement Great position for squatting down and pedaling in reverse Simulates runners movement or when moving fast
Zone 5	Narrow vertical position	Great for pulling or pushing of the arms Focuses on the lat (back), triceps (back of arm), and biceps (front of arm) muscles

No matter what position or zone you select, you're working numerous different muscle groups throughout your upper-body to get a true elliptical cross training workout. You can emphasize either a push or pull movement or reposition your hands any time during any program for maximal muscle exertion, balance, variety, and comfort.

## The Optional CROSS CiRCUIT<sup>+</sup> Kit

Enhance your workout experience with the Octane Fitness CROSS CiRCUIT<sup>+</sup> Kit. The kit, designed specifically for your Q37 elliptical, includes stationary foot platforms that attach to the frame of the unit and three additional Powerbands to help you complete the CROSS CiRCUIT exercises.

For more information, or to purchase the CROSS CiRCUIT<sup>+</sup> Kit, please contact your Octane Fitness dealer.

## Learn More at [www.octanefitness.com](http://www.octanefitness.com)

Log on to [www.octanefitness.com](http://www.octanefitness.com) where you will find additional information about product features and answers to many common questions and tips on using your elliptical. If you would like to speak to an Octane Fitness Customer Service specialist, please call 1-888-OCTANE4 or 763-757-2662, extension 1.

# NOTES

---

---

---

---

---

---

---

---

---

---

---

---

---

---

---

---

---

---

---

---

---

---

---

---





*Are you passionate about your workout and the results?*

Share your story with others on the Octane Fitness web site.

Go to: *www.octanefitness.com/testimonials*

Then click on "Share My Story" and  
show the world how fueled you are.

**F U E L Y O U R L I F E <sup>TM</sup>**



**Octane Fitness**

*US & Canada, Latin America, Asia & Asian Pacific*

9200 Wyoming Avenue North

Suite 380

Brooklyn Park, MN 55445

Phone: 888.OCTANE4 (US and Canada)

763.757.2662 (Latin America, Asia and Asian Pacific)

Fax: 763.323.2064

**Octane Fitness International**

*Europe, Middle East, Africa*

Rivium Weestlaan 19

2909 LD, Capelle a/d IJssel

The Netherlands

Phone: +31 10 2662412

Fax: +31 10 2662444

*www.octanefitness.com*

*www.youtube.com/user/octanefitness*



Find us on

Facebook

*www.facebook.com/octanefitness*

©2010 Octane Fitness, LLC. All rights reserved. Octane Fitness, DedicatedLogic, Fuel Your Life, HeartLogic, Now-Zone, X-Mode, ArmBlaster, GluteKicker, and SmartStride are registered trademarks of Octane Fitness. Any use of these trademarks, without the express written consent of Octane Fitness, is forbidden.

104190-001 REV C